

LA350H

Dimension

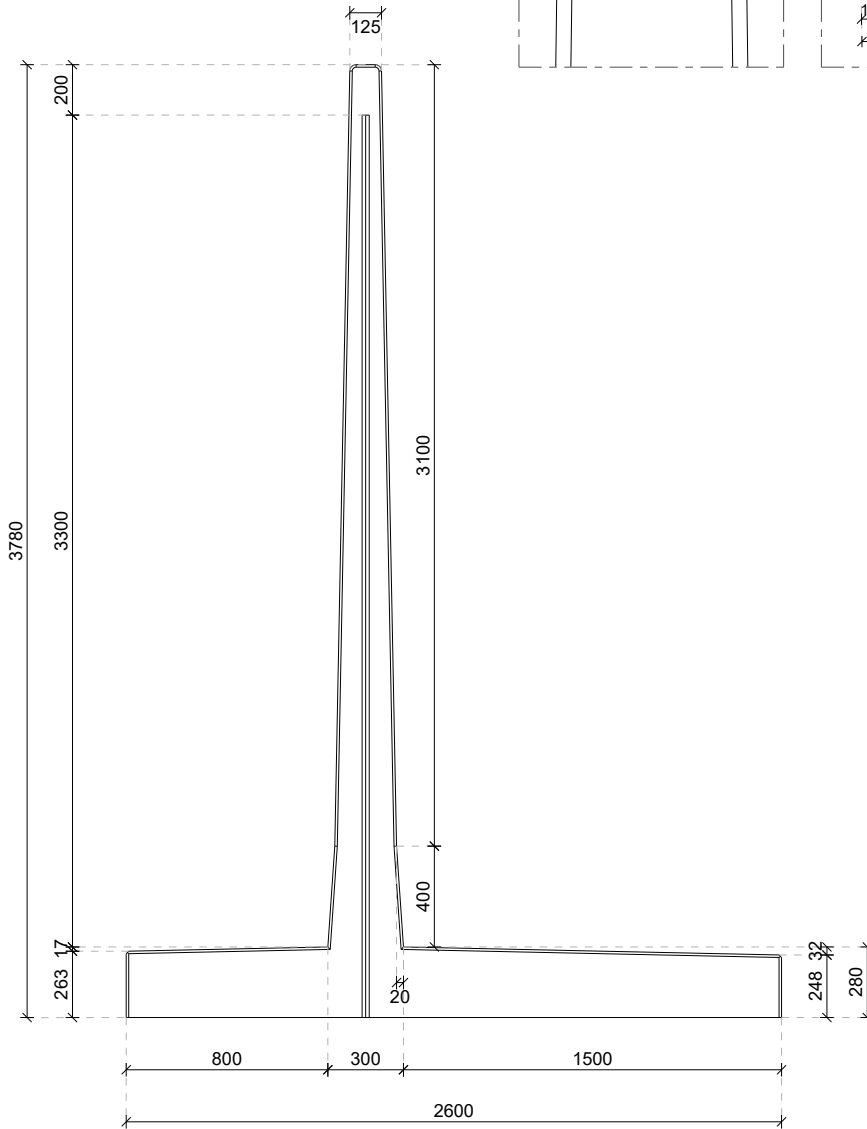

Détails

Dessus arrondi

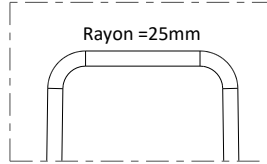

Rainure en V

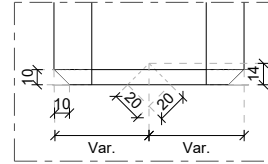

Connexion des éléments

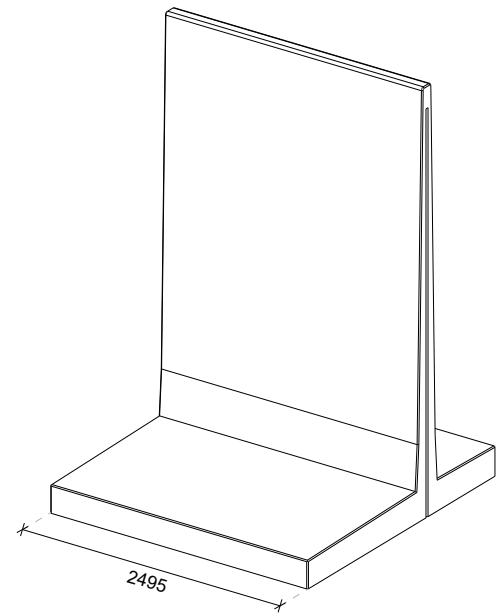
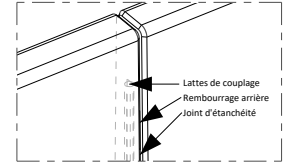

Spécifications

Mélange de Béton 2nd Generation self-compacting C60/75
Armature en acier B500
Poids 8170kg (L=2495mm)

Enrobage 30mm
Tolérance dimensionnelle +/-5mm
Classe visible de béton Tous les côtés de visibilité A (supérieur)
Dispositif de levage Aucun, endroits avec la pince
Garantie du produit 15 ans
Classe écologique XA3, XC4, XD3, XS3, XF4
50 ans(XA3, XD3, XS3)
100 ans(XC4, XF4)

Construit conformément à

NF-EN 1990 Eurocode 0 NF-EN 206
NF-EN 1991 Eurocode 1 Incl. annexes nationales
NF-EN 1992 Eurocode 2
NF-EN 1997 Eurocode 7

Méthode de production



Énergie neutre



Eau de pluie filtrée



Matières premières durables



Matières recyclables

Certifié

