

# TYPE LR225S

## Dimension

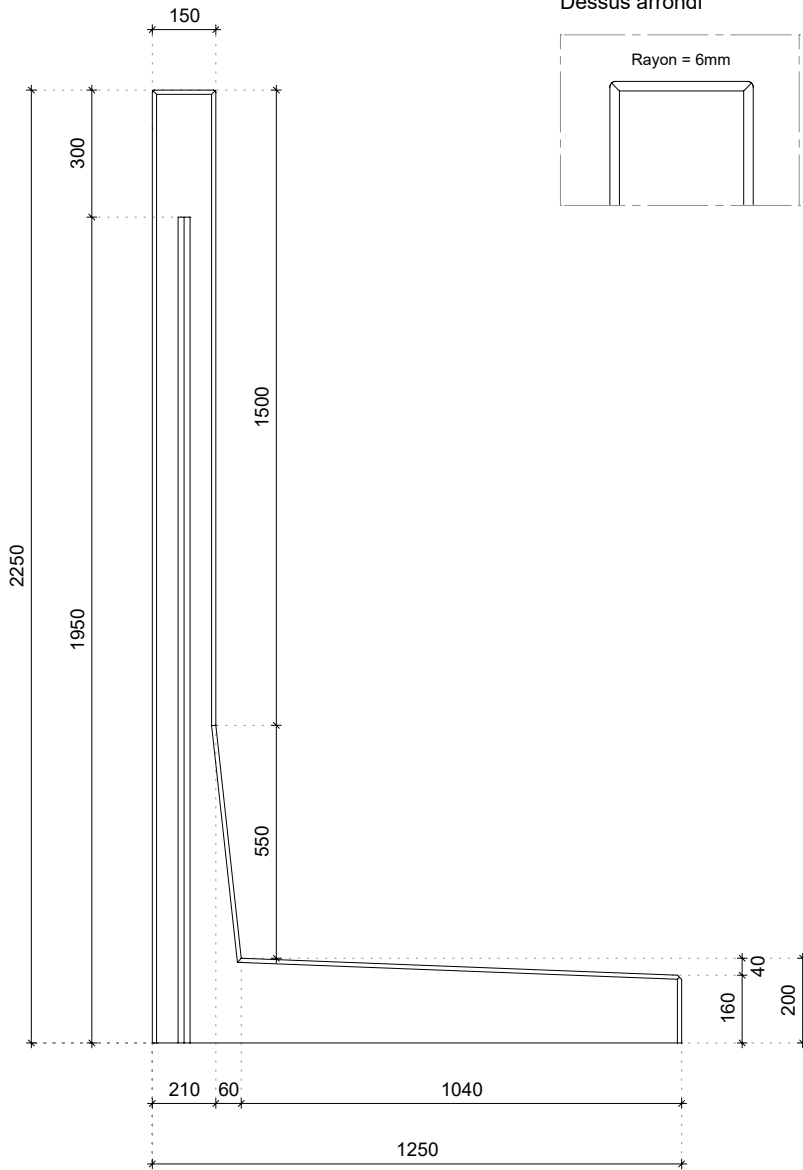

## Détails

### Dessus arrondi

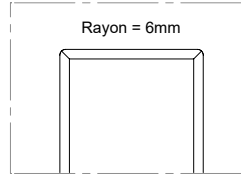

### Rainure en V

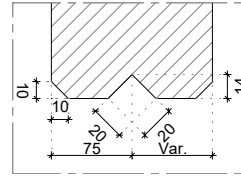

### Connexion des éléments

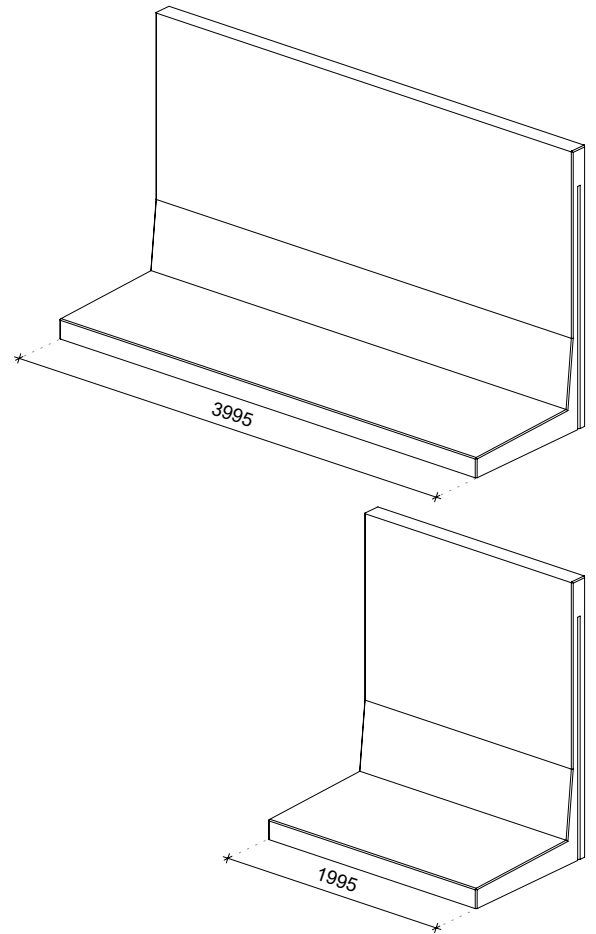
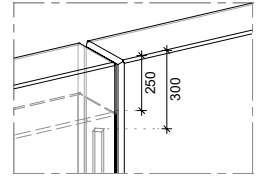

## Spécifications

Mélange de béton	2nd Generation self-compacting C60/75
Armature en acier	B500
Poids	5243kg (L = 3995mm) / 2695kg (L = 1995mm)
Enrobage	45mm
Tolérance dimensionnelle	+/- 5mm
Classe visible de béton	Tous les côtés de visibilité A (supérieur)
Vie de conception	100 ans
Garantie du produit	10 ans
Classe écologique	XA3, XC4, XD3, XS3, XF4
Dispositif de levage	Aucun, endroits avec la pince

## Construit conformément à

NF-EN 1990 Eurocode 0	NF-EN 206
NF-EN 1991 Eurocode 1	Incl. annexes nationales
NF-EN 1992 Eurocode 2	
NF-EN 1997 Eurocode 7	

## Méthode de production



Énergie  
neutre



Eau de  
pluie filtrée



Matières premières  
durables



Matières  
recyclables

## Certifié

