

TYPE TRAPU175

Dimension

Vue latérale

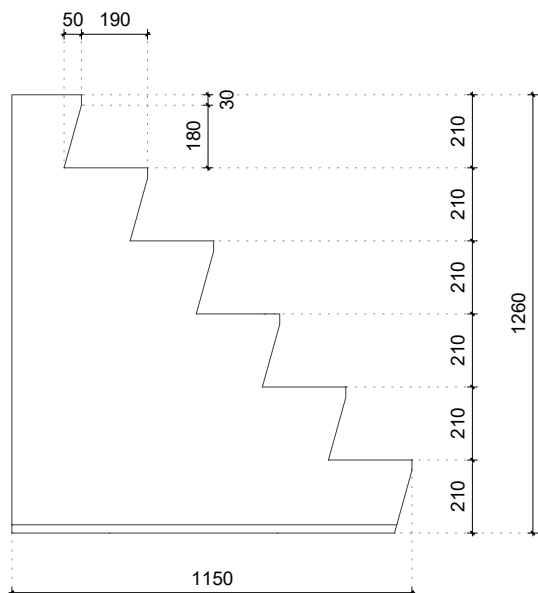

Vue de face

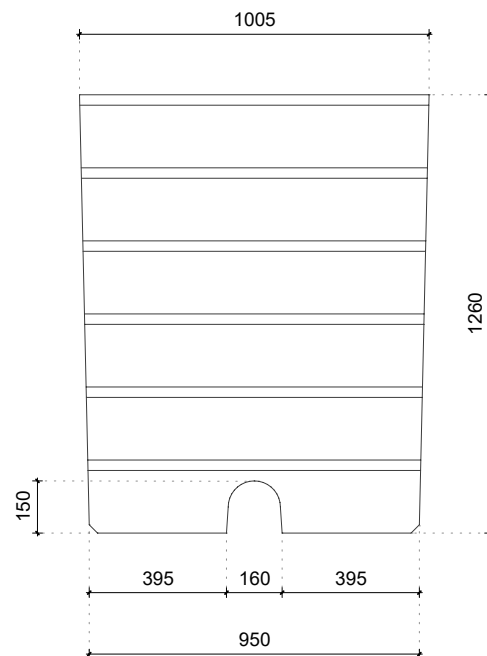

Vue de dessus

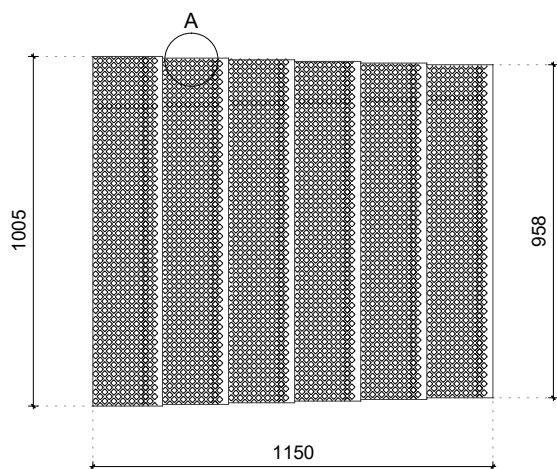

Détail A

Antidérapant, hauteur 0,3 mm

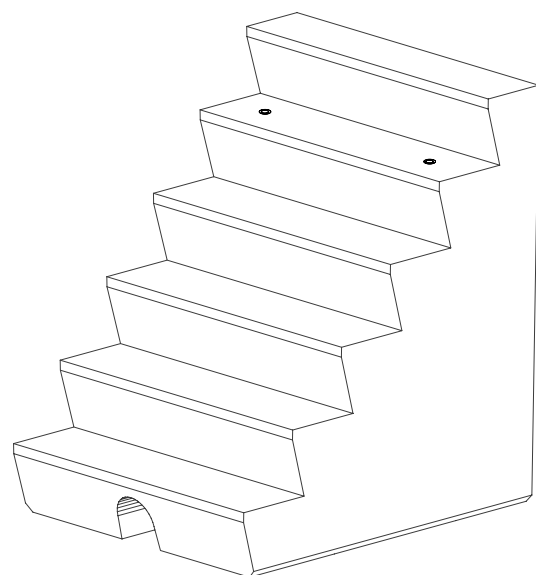
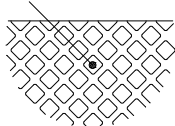

Spécifications

Mélange de béton	2nd generation self-compacting C60/67
Poids	1805kg
Tolérance dimensionnelle	+/- 5mm
Classe écologique	XA3
Dispositif de levage	ancre à tête sphérique (DEHA) 2 x 5 Tonnes

Méthode de production



Énergie neutrale



Eau de pluie filtrée



Matières premières durables



Matières recyclables

Certifié

