

TYPE TWA200

Dimension

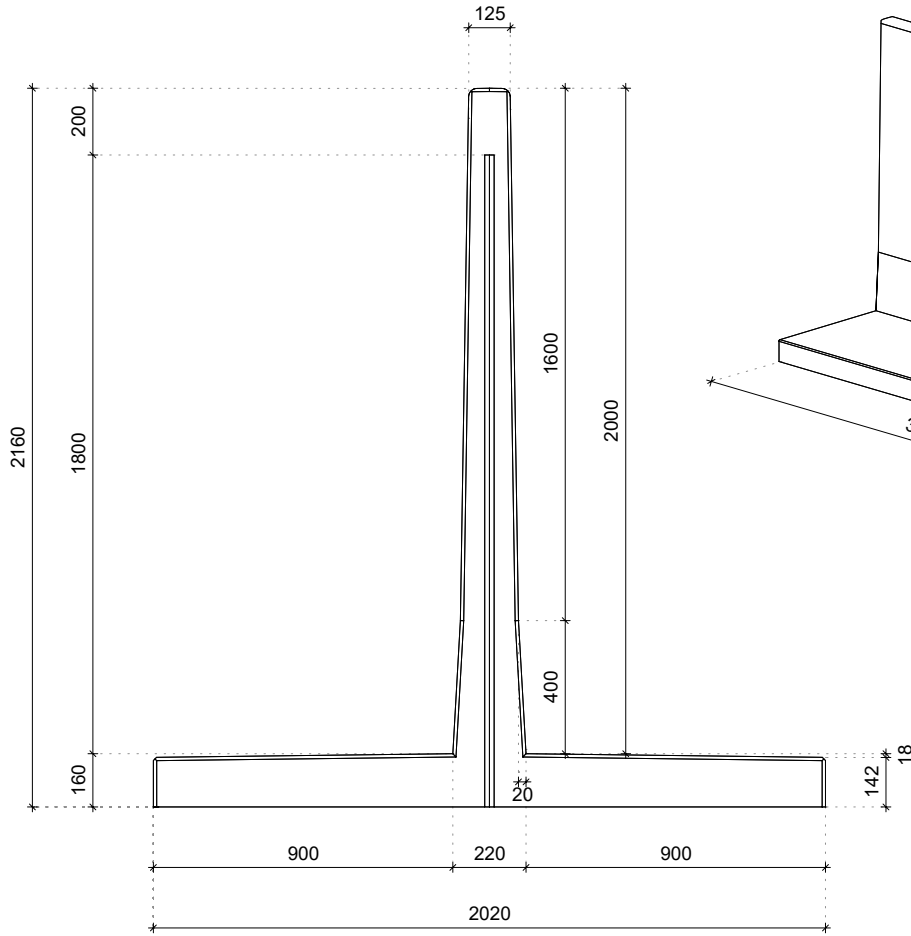

Détails

Dessus arrondi

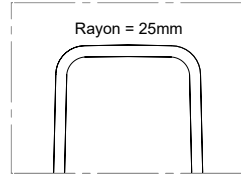

Rainure en V

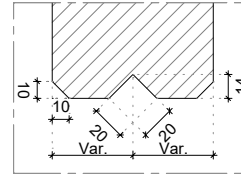

Connexion des éléments

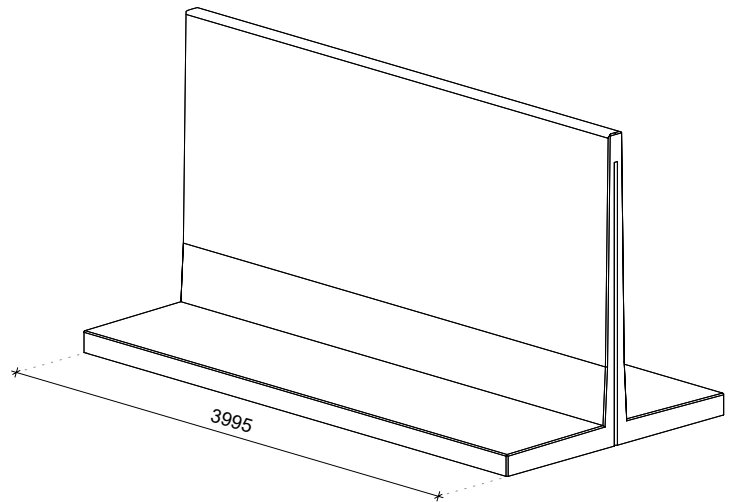
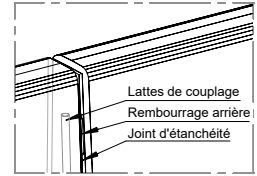

Spécifications

Mélange de béton	2nd Generation self-compacting C60/75
Armature en acier	B500
Poids	5920kg (L = 3995mm)
Enrobage	30mm
Tolérance dimensionnelle	+/- 5mm
Classe visible de béton	Tous les côtés de visibilité A (supérieur)
Vie de conception	50 ans
Garantie du produit	20 ans
Classe écologique	XA3, XC4, XD3, XS3, XF4
Dispositif de levage	Aucun, endroits avec la pince

Construit conformément à

NF-EN 1990 Eurocode 0	NF-EN 206
NF-EN 1991 Eurocode 1	Incl. annexes nationales
NF-EN 1992 Eurocode 2	
NF-EN 1997 Eurocode 7	

Méthode de production



Énergie
neutre



Eau de
pluie filtrée



Matières premières
durables



Matières
recyclables

Certifié

